



NETWORK RECORDER MC 750

- Measurements of instantaneous values of more than **140 quantities**.
- **Class S** measuring accuracy according to EN 61000-4-30.
- Voltage and current auto range measurements up to 1000 V_{RMS}, 12.5 A.
- **Wide frequency** measurement range 16 Hz – 400 Hz.
- Up to **three independent communication ports**.
- Support for **NTP real time synchronisation**.
- Up to **4 inputs/outputs**.

FEATURES

- Measurements of instantaneous values of more than 140 quantities including harmonics, power line signalling voltage, unbalance, etc...
- Class S (0.2%) accuracy in compliance with EN 61000-4-30.
- Four quadrant energy measurement with class 0.5 S or 0.2 S for active energy (8 programmable energy counters, up to four tariffs, tariff clock, etc.).
- Automatic range selection of 3 current and 4 voltage channels (max. 12.5 A and 1000 V_{RMS}) with 32 kHz sampling rate.
- Recording all measured parameters including all voltage and current harmonics up to 63rd, 32 adjustable alarms, anomalies and quality reports in the internal memory.
- Measurements of 40 minimal and maximal values in different time intervals (from 1 period to 256 periods).
- Frequency range from 16 Hz to 400 Hz.
- Up to three independent communication ports (RS232 or RS485 up to 115,200 bit/s, Ethernet and USB 2.0).
- MODBUS and DNP3 communication protocols.
- Support for NTP real time synchronisation.
- Up to 4 inputs and outputs (analogue inputs/outputs, digital inputs/outputs, alarm/watchdog outputs, pulse input/outputs, tariff inputs).
- Multilingual support.
- Universal power supply.
- 96 mm square panel mounting.
- User-friendly setting and evaluation software, MiQen.
- Extension unit with four configurable analogue outputs – EX104 (0.4 mA_{DC} ... 20 mA_{DC}, 0 V_{DC} ... 10 V_{DC}).

DESCRIPTION

MC 750 Network Recorder is an important device for permanent monitoring measuring and analysing single-phase or three-phase electrical power network.

The meter measures RMS value according to the principle of fast sampling of voltage and current signals. A built-in microprocessor calculates measurands (voltage, current, frequency, energy, power, power factor, THD phase angles, etc.) from the measured signals.

MC 750 performs measurements in compliance with regulatory requested standard EN 61000-4-30.

All required measurements and alarms can also be stored locally in an internal memory. With the RS232/RS485 or Ethernet/USB communication the meter can be set, measurements checked, and stored data downloaded.

APPLICATION AND BENEFITS

MC 750 Network recorder is intended for monitoring, measuring and recording of electrical quantities of a three-phase electric-energy distribution system.

Identifying relevant fixed measuring points is the most important task prior to complete system installation. This system itself will not prevent disturbances in network but it will help diagnose their origin and effects. This is possible only with system approach by using time synchronized meters with wide range of measuring parameters.

COMPLIANCE WITH STANDARDS

MC 750 Network recorder follows required procedures and meets the precision requirements for class S measuring device as described in standard IEC EN 61000-4-30.

Standard EN	Description
61010-1:2010	<i>Safety requirements for electrical equipment for measurement, control and laboratory use.</i>
61557-12:2018	<i>Electrical safety in LV distribution systems up to 1 kV a.c. and 1.5 kV d.c. – Combined performance measuring and monitoring devices for electrical parameters.</i>
61000-4-30:2009	<i>Electromagnetic compatibility (EMC) – Power quality measurements methods.</i>
61000-4-7:2002 + A1:2009	<i>Electromagnetic compatibility (EMC) – General guide on harmonics and inter-harmonics measurements.</i>
50160:2011	<i>Voltage characteristics of electricity supplied by public distribution networks.</i>
62053-22:2003	<i>Electricity metering equipment - Static meters for active energy (classes 0.2 S and 0.5 S).</i>
62053-24:2014	<i>Electricity metering equipment – Static meters for reactive energy at fundamental frequency (classes 0,5 S, 1 S and 1)</i>
62053-23:2003	<i>Electricity metering equipment -Static meters for reactive energy (classes 2 and 3).</i>
61326-1:2006	<i>EMC requirements for electrical equipment for measurement, control and laboratory use.</i>
60529:1997/A1:2000	<i>Degrees of protection provided by enclosures (IP code).</i>
60068-2-1/ -2/ -6/ -27/-30	<i>Environmental testing (-1 Cold, -2 Dry heat, -30 Damp heat, -6 Vibration, -27 Shock).</i>
UL 94	<i>Tests for flammability of plastic materials for parts in devices and appliances.</i>

Table 1: List of applicable standards

MEASUREMENTS

ONLINE MEASUREMENTS

NOTE!

In MiQen settings, software device will represent itself as MC 750A.

Online measurements are available on display or can be monitored with setting and monitoring software **MiQen**.

Readings on display are performed continuously with refresh time dependent on set average interval whereas rate of readings monitored with **MiQen** is fixed and refreshed approx. each second.

For better overview over numerous readings, they are divided into several groups, which contain basic measurements, min. and max. values, harmonics and alarms.

Each group can represent data in visually favored graphical form or detailed tabular form. Latter allows freezing readings and/or copying data into various report generation software tools.

INTERACTIVE INSTRUMENT

Additional communication feature of a device allows interactive handling with a dislocated device as if it would be operational in front of user.

This feature is useful for presentations or product training.

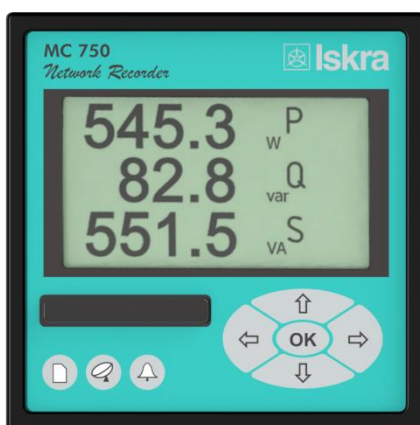

SELECTION OF AVAILABLE QUANTITIES

Available online measuring quantities and their appearance can vary according to set type of power network and other settings such as; average interval, max. demand mode, reactive power calculation method ...

Complete selection of available online measuring quantities is shown in a table on the next page.

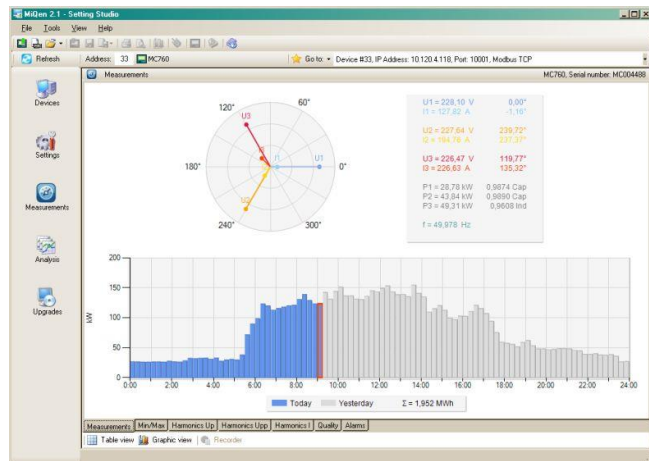

Figure 3: The sample of online measurements in graphical form – phase diagram and daily total active power consumption histogram

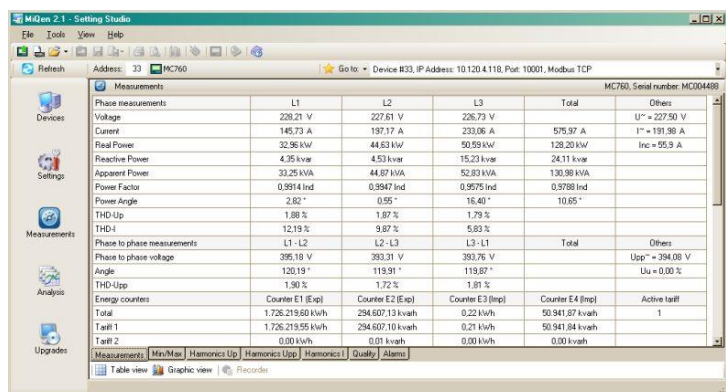

Figure 4: The sample of online measurements in tabular form

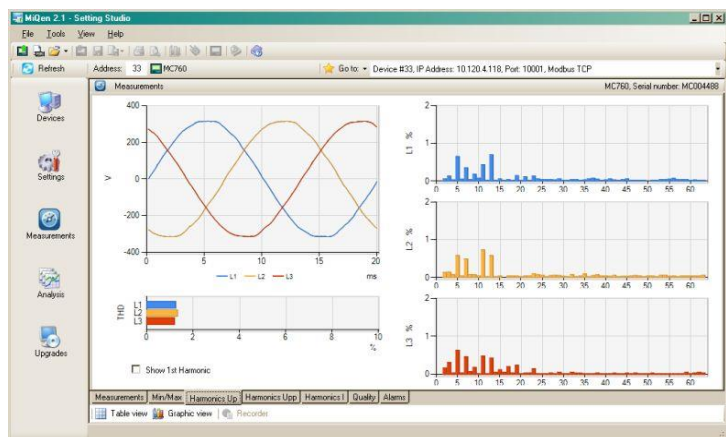















Figure 5: The sample of online harmonic measurements in graphical form

Meas. type	Measurement	3-phase 4-wire	3-phase 3-wire	1-phase	comments
Phase measurements	<i>Voltage</i>				
	U _{1-3_RMS}	<input checked="" type="checkbox"/>		<input checked="" type="checkbox"/> 1ph	
	U _{AVG_RMS}	<input checked="" type="checkbox"/>		<input checked="" type="checkbox"/>	
	U _{1-3_DC}	<input checked="" type="checkbox"/>		<input checked="" type="checkbox"/> 1ph	DC component of phase voltages
	<i>Current</i>				
	I _{1-3_RMS}	<input checked="" type="checkbox"/>	<input checked="" type="checkbox"/>	<input checked="" type="checkbox"/> 1ph	
	I _{TOT_RMS}	<input checked="" type="checkbox"/>	<input checked="" type="checkbox"/>	<input checked="" type="checkbox"/>	
	I _{AVG_RMS}	<input checked="" type="checkbox"/>	<input checked="" type="checkbox"/>	<input checked="" type="checkbox"/>	
	I _{NEUTRAL_calc}	<input checked="" type="checkbox"/>	<input checked="" type="checkbox"/>	<input checked="" type="checkbox"/>	Calculated neutral current
	<i>Power</i>				
	P _{1-3_RMS}	<input checked="" type="checkbox"/>		<input checked="" type="checkbox"/> 1ph	
	P _{TOT_RMS}	<input checked="" type="checkbox"/>	<input checked="" type="checkbox"/>	<input checked="" type="checkbox"/>	
	Q _{1-3_RMS}	<input checked="" type="checkbox"/> 		<input checked="" type="checkbox"/> 1ph 	Reactive power can be calculated as a squared difference between S and P or as delayed sample
	Q _{TOT_RMS}	<input checked="" type="checkbox"/>	<input checked="" type="checkbox"/>	<input checked="" type="checkbox"/>	
	S _{1-3_RMS}	<input checked="" type="checkbox"/>		<input checked="" type="checkbox"/> 1ph	
	S _{TOT_RMS}	<input checked="" type="checkbox"/>	<input checked="" type="checkbox"/>	<input checked="" type="checkbox"/>	
	Q _{fund1-3_RMS}	<input checked="" type="checkbox"/> 		<input checked="" type="checkbox"/> 1ph 	Fundamental reactive power of first harmonics
	Q _{fundTOT_RMS}	<input checked="" type="checkbox"/>	<input checked="" type="checkbox"/>	<input checked="" type="checkbox"/>	
	PF ₁₋₃	<input checked="" type="checkbox"/>		<input checked="" type="checkbox"/> 1ph	
	PF _{TOT}	<input checked="" type="checkbox"/>	<input checked="" type="checkbox"/>	<input checked="" type="checkbox"/>	
	φ ₁₋₃	<input checked="" type="checkbox"/>		<input checked="" type="checkbox"/> 1ph	PA – Power angle
	<i>Harmonic analysis</i>				
	THD-U ₁₋₃	<input checked="" type="checkbox"/>		<input checked="" type="checkbox"/> 1ph	
	THD-I ₁₋₃	<input checked="" type="checkbox"/>	<input checked="" type="checkbox"/>	<input checked="" type="checkbox"/> 1ph	
	TDD-I ₁₋₃	<input checked="" type="checkbox"/>	<input checked="" type="checkbox"/>	<input checked="" type="checkbox"/> 1ph	
	U _{1-3_harmonic_1-63_%}	<input checked="" type="checkbox"/> 		<input checked="" type="checkbox"/> 1ph 	% of RMS or % of base
	U _{1-3_harmonic_1-63_ABS}	<input checked="" type="checkbox"/>		<input checked="" type="checkbox"/> 1ph	
	U _{1-3_harmonic_1-63_φ}	<input checked="" type="checkbox"/>		<input checked="" type="checkbox"/> 1ph	
	I _{1-3_harmonic_1-63_%}	<input checked="" type="checkbox"/> 	<input checked="" type="checkbox"/> 	<input checked="" type="checkbox"/> 1ph 	% of RMS or % of base
	I _{1-3_harmonic_1-63_ABS}	<input checked="" type="checkbox"/>	<input checked="" type="checkbox"/>	<input checked="" type="checkbox"/> 1ph	
	I _{1-3_harmonic_1-63_φ}	<input checked="" type="checkbox"/>	<input checked="" type="checkbox"/>	<input checked="" type="checkbox"/> 1ph	
Phase to phase measurements	<i>Voltage</i>				
	U _{pp1-3_RMS}	<input checked="" type="checkbox"/>	<input checked="" type="checkbox"/>		
	U _{ppAVG_RMS}	<input checked="" type="checkbox"/>	<input checked="" type="checkbox"/>		
	φ _{x-y}	<input checked="" type="checkbox"/>	<input checked="" type="checkbox"/>		Phase-to-phase angle
	<i>Harmonic analysis</i>				
	THD-U _{pp1-3}	<input checked="" type="checkbox"/>	<input checked="" type="checkbox"/>		
	U _{pp1-3_harmonic_1-63_%}	<input checked="" type="checkbox"/> 	<input checked="" type="checkbox"/> 		% of RMS or % of base
	U _{pp1-3_harmonic_1-63_ABS}	<input checked="" type="checkbox"/>	<input checked="" type="checkbox"/>		
	U _{pp1-3_harmonic_1-63_φ}	<input checked="" type="checkbox"/>	<input checked="" type="checkbox"/>		

Meas. type	Measurement	3-phase 4-wire	3-phase 3-wire	1-phase	comments	
Metering	<i>Energy</i>					
	Counter E ₁₋₈	<input checked="" type="checkbox"/>	<input checked="" type="checkbox"/>	<input checked="" type="checkbox"/>	Each counter can be dedicated to any of four quadrants (P-Q, import-export, L-C). Total energy is a sum of one counter for all tariffs. Tariffs can be fixed, date/time dependent or tariff input dependent	
	E _{TOT_1-8}	<input checked="" type="checkbox"/>	<input checked="" type="checkbox"/>	<input checked="" type="checkbox"/>		
	Active tariff	<input checked="" type="checkbox"/>	<input checked="" type="checkbox"/>	<input checked="" type="checkbox"/>		
	Cost _{by_meters} ₁₋₄	<input checked="" type="checkbox"/>	<input checked="" type="checkbox"/>	<input checked="" type="checkbox"/>	Calculated costs depend on specified price per hour and currency	
	Cost _{1-4_TOT}	<input checked="" type="checkbox"/>	<input checked="" type="checkbox"/>	<input checked="" type="checkbox"/>		
Maximum demand measurements	<i>Maximum demand</i>					
	MD _{I_1-3}	<input checked="" type="checkbox"/>	<input checked="" type="checkbox"/>	<input checked="" type="checkbox"/> 1ph		
	MD _{P_import}	<input checked="" type="checkbox"/>	<input checked="" type="checkbox"/>	<input checked="" type="checkbox"/>		
	MD _{P_export}	<input checked="" type="checkbox"/>	<input checked="" type="checkbox"/>	<input checked="" type="checkbox"/>		
	MD _{Q_ind}	<input checked="" type="checkbox"/>	<input checked="" type="checkbox"/>	<input checked="" type="checkbox"/>		
	MD _{Q_cap}	<input checked="" type="checkbox"/>	<input checked="" type="checkbox"/>	<input checked="" type="checkbox"/>		
Min and max measurements	<i>Min and max</i>					
	U _{1-3_RMS_MIN}	<input checked="" type="checkbox"/>		<input checked="" type="checkbox"/> 1ph		
	U _{1-3_RMS_MAX}	<input checked="" type="checkbox"/>		<input checked="" type="checkbox"/> 1ph		
	U _{pp1-3_RMS_MIN}	<input checked="" type="checkbox"/>	<input checked="" type="checkbox"/>	<input checked="" type="checkbox"/>		
	U _{pp1-3_RMS_MAX}	<input checked="" type="checkbox"/>	<input checked="" type="checkbox"/>	<input checked="" type="checkbox"/>		
	I _{1-3_RMS_MIN}	<input checked="" type="checkbox"/>	<input checked="" type="checkbox"/>	<input checked="" type="checkbox"/> 1ph		
	I _{1-3_RMS_MAX}	<input checked="" type="checkbox"/>	<input checked="" type="checkbox"/>	<input checked="" type="checkbox"/> 1ph		
	P _{1-3_RMS_MIN}	<input checked="" type="checkbox"/>		<input checked="" type="checkbox"/> 1ph		
	P _{1-3_RMS_MAX}	<input checked="" type="checkbox"/>		<input checked="" type="checkbox"/> 1ph		
	P _{TOT_RMS_MIN}	<input checked="" type="checkbox"/>	<input checked="" type="checkbox"/>	<input checked="" type="checkbox"/> 1ph		
	P _{TOT_RMS_MAX}	<input checked="" type="checkbox"/>	<input checked="" type="checkbox"/>	<input checked="" type="checkbox"/> 1ph		
	S _{1-3_RMS_MIN}	<input checked="" type="checkbox"/>		<input checked="" type="checkbox"/> 1ph		
	S _{1-3_RMS_MAX}	<input checked="" type="checkbox"/>		<input checked="" type="checkbox"/> 1ph		
	S _{TOT_RMS_MIN}	<input checked="" type="checkbox"/>	<input checked="" type="checkbox"/>	<input checked="" type="checkbox"/> 1ph		
	S _{TOT_RMS_MAX}	<input checked="" type="checkbox"/>	<input checked="" type="checkbox"/>	<input checked="" type="checkbox"/> 1ph		
	freq _{MIN}	<input checked="" type="checkbox"/>	<input checked="" type="checkbox"/>	<input checked="" type="checkbox"/>		
	freq _{MAX}	<input checked="" type="checkbox"/>	<input checked="" type="checkbox"/>	<input checked="" type="checkbox"/>		
	Other measurements	<i>Miscellaneous</i>				
		freq _{MEAN}	<input checked="" type="checkbox"/>	<input checked="" type="checkbox"/>	<input checked="" type="checkbox"/>	
		Internal temp.	<input checked="" type="checkbox"/>	<input checked="" type="checkbox"/>	<input checked="" type="checkbox"/>	
Date, Time		<input checked="" type="checkbox"/>	<input checked="" type="checkbox"/>	<input checked="" type="checkbox"/>		
Last Sync. time		<input checked="" type="checkbox"/> 	<input checked="" type="checkbox"/> 	<input checked="" type="checkbox"/> 	UTC	

 For more information see **MC 7×0A Power Monitoring Device** User's manual

Table 3: Selection of available measurement quantities

DESCRIPTION OF PROPERTIES

RECORDER

A built-in recorder (8 Mb) enables storing measurements, detected alarms and PQ reports with details. It supports recording of all measured quantities including voltage and current harmonics in 4 configurable partitions. For each partition is possible to set storage interval and other recording parameters.

Fifth partition is used for recording alarms. Each alarm triggered by pre-set limit lines is stored in a form of alarm i.d. and its timestamp.

Memory card

MC 750 Network Recorder is equipped with a front panel slot for full sized SD memory card that supports capacity up to 2 GB. It is intended for downloading internally stored data, uploading setting file and performing firmware upgrade.

Alarms

Alarms are powerful tool for **MC 750 Network Recorder** control and supervision features. Devices' performance can with this features reach beyond measuring and analyzing power network.

MC 750 Network Recorder supports recording and storing of 32 alarms in four groups. A time constant of maximal values in a thermal mode, a delay time and switch-off hysteresis are defined for each group of alarms.

For each parameter is possible to set limit value, condition and alarm activation action (sound signal and/or digital output switch if available).

All alarms are also stored in internal memory for post-analysis.

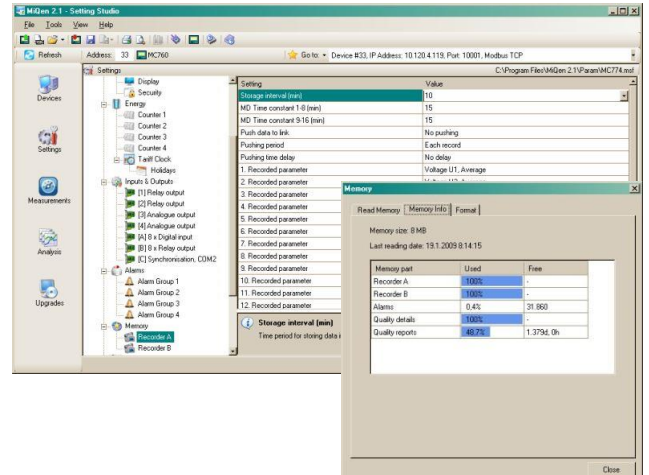

Figure 6: The sample of setting recorder parameters and viewing memory consumption information

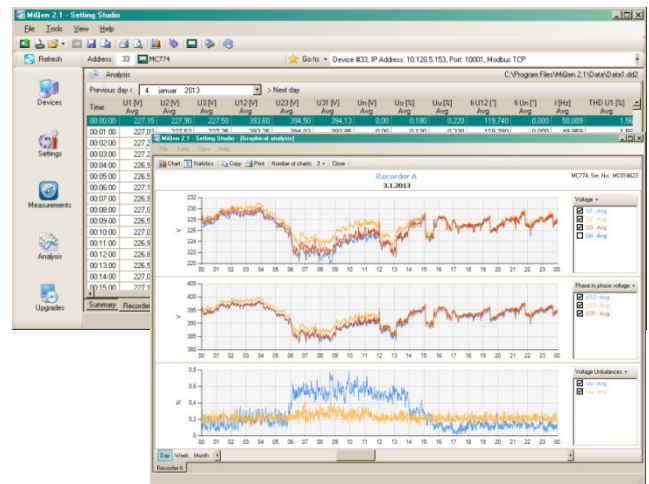

Figure 7: The sample of viewing recorder content in tabular and graphical form

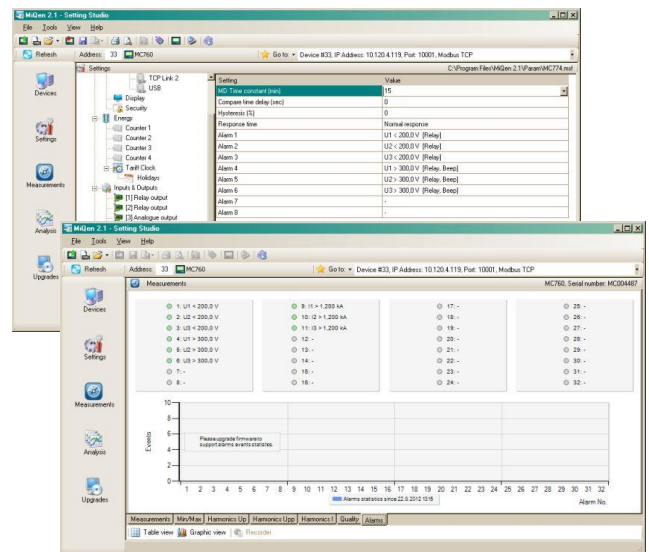

Figure 8: The sample of setting and viewing alarms

REAL TIME SYNCHRONISATION

Synchronized real-time clock (RTC) is an essential part of any Class A analyzer for proper chronological determination of various events.

To distinct cause from consequence, to follow a certain event from its origin to manifestation in other parameters it is very important that each and every event and recorded measurement on one instrument can be compared with events and measurements on other devices. Even if instruments are dislocated, which is normally the case in electro distribution network events have to be time-comparable with accuracy better than a single period.

For this purpose, instruments normally support highly accurate internal RTC. Still this is not enough, since temperature is location dependant and it influences its precision. For that reason, it is required to implement periodical RTC synchronization.

MC 750 Network Recorder supports Network time protocol synchronization (NTP).

Network time protocol (NTP):

Synchronization via Ethernet requires access to an NTP server.

NOTE: NTP can usually maintain time to within tens of milliseconds over the public Internet, but the accuracy depends on infrastructure properties - asymmetry in outgoing and incoming communication delay affects systematic bias. It is recommended that dedicated network rather than public network is used for synchronisation purposes.

COMMUNICATION

MC 750 Network Recorder has a wide variety of communication possibilities to suit specific demands. It is equipped with standard communication port COM1 and auxiliary communication port COM2. This allows two different users to access data from a device simultaneously and by using TCP/IP communication, data can be accessed worldwide.

COM2 port is optional and can be ordered as one of I/O modules.

Different configurations are possible (to be specified with an order).

Configuration	COM1	COM2
1	RS232/485	/
2	RS232/485	RS232 or RS485
3 ⁽¹⁾	Ethernet & USB	/
4 ⁽¹⁾	Ethernet & USB	RS232 or RS485

⁽¹⁾ Galvanic separation between Eth. and USB is 1 kVACRMS

Table 4: List of communication configurations

MC 750 Network Recorder supports standard communication protocols MODBUS RTU, TCP and DNP3 L1.

Additionally, it supports proprietary PUSH communication mode, which is used in system applications where devices send predefined readings in predefined time intervals in XML format. Web based software MiSMART collects data and stores it into database. Stored data can then be viewed with MiSMART client software.

For more information about PUSH communication mode and XML format see **MC 750 Network Recorder** User's manual.

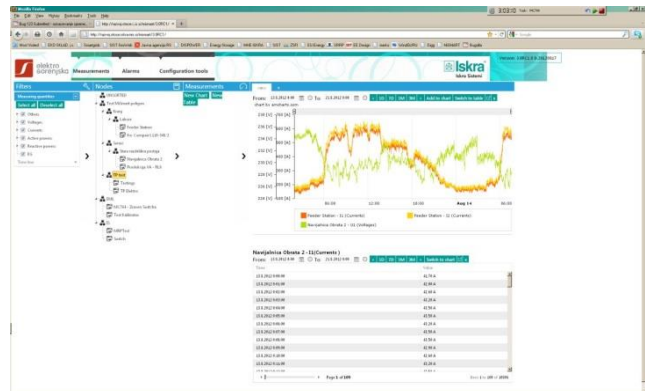

Figure 9: MiSMART client window

Analogue extender EX104 (accessory)

If there is a demand for additional analogue outputs analogue extender EX104 can be used.

It is a standalone unit, connected to meter via module 2 (module for communication with EX104 needs to be specified at order). Up to 4 analogue outputs can be used with one meter. More information can be found in Analogue extender EX104 data sheet (E P22.495.400).

TECHNICAL DATA

Measurement inputs

Nominal frequency range	50 Hz, 60 Hz
Measuring frequency range	16 Hz–400 Hz

Voltage measurements:

Number of channels	4 ⁽¹⁾
Sampling rate	32 kHz
Min. voltage for sync.	1 V _{rms}
Nominal value (U _N)	500 V _{LN} , 866 V _{LL}
Max. measured value (cont.)	600 V _{LN} ; 1000 V _{LL}
Max. allowed value	1.2 × U _N permanently 2 × U _N ; 10 s
Consumption	< U ² / 4.2MΩ per phase
Input impedance	4.2MΩ per phase

⁽¹⁾ 4th channel is used for measuring U_{EARTH-NEUTRAL}

Current measurements:

Number of channels	3
Sampling rate	32 kHz
Nominal value (I _{NOM})	1 A, 5 A
Max. measured value (I ₁ -I ₃ only)	12.5 A sin.
Max. allowed value (thermal)	15 A cont.
	≤ 300 A; 1s
Consumption	< I ² × 0.01Ω per phase

Basic accuracy under reference conditions

Accuracy is presented as percentage of reading of the measurand except when it is stated as an absolute value.

Measurand	Accuracy class	According to
Voltage L-N, L-L	0.2	EN 61557-12
Current	0.2	EN 61557-12
Active power (I _N = 5 A)	0.2	EN 61557-12
Active power (I _N = 1 A)	0.5	EN 61557-12
Active energy	0.5S	EN 62053-22
Reactive energy	1	EN 62053-24
Frequency (f)	0.02 Class A	EN 61557-12
Power factor (PF)	0.5	EN 61557-12
THD (U)	0.3 Class I / A	EN 61557-12
THD (I)	0.3	EN 61557-12
Real time clock (RTC)	< ± 1 s/day	IEC 61000-4-30

For complete overview of accuracy for all measured parameters and measuring ranges see Users' manual.

INPUT/OUTPUT modules

MC 750 Network Recorder is equipped with two main I/O slots. According to order, each slots' function can be as presented in a table below.

Module type	Number of I/O per module
Relay output (RO)	2
Analogue output (AO)	2 x 20 mA
Analogue input (AI)	2
Pulse output (PO)	2
Pulse input (PI)	2
Bistable Digital output (BO)	1
Digital output (DO)	2
Digital input (DI)	2
Tariff input (TI)	2
Additional communication port (COM2)	1
Status output (WO)	1 + 1xRO
Communication port for analogue extender EX104	1

Table 5: List of available I/O modules

Analogue input:

Three types of analogue inputs are suitable for acquisition of low voltage DC signals from different sensors. According to application requirements it is possible to choose current, voltage or resistance (temperature) analogue input. They all use the same output terminals.

MiQen software allows setting an appropriate calculation factor, exponent and required unit for representation of primary measured value (temperature, pressure, wind speed ...)

DC current input:

Nominal input range	-20 mA...0...20 mA (±20%)
Input resistance	20 Ω
Accuracy	0.5 % of range
Temperature drift	0.01% / °C
Conversion resolution	16 bit (sigma-delta) internally referenced
Analogue input mode	Single-ended

DC voltage input:

Nominal input range	-10 V...0...10 V ($\pm 20\%$)
Input resistance	100 k Ω
Accuracy	0.5 % of range
Temperature drift	0.01% / °C
Conversion resolution	16 bit (sigma-delta) internally referenced
Analogue input mode	Single-ended

Resistance (temperature) input:

Nominal input range (low)*	0 Ω - 200 Ω (max. 400 Ω) PT100 (-200°C–850°C)
Nominal input range (high)*	0 k Ω – 2 k Ω (max. 4 k Ω) PT1000 (-200°C–850°C)
Connection	2-wire
Accuracy	0.5 % of range
Conversion resolution	16 bit (sigma-delta) internally referenced
Analogue input mode	Single-ended

* Low or high input range and primary input value (resistance or temperature) are set by the MiQen setting software

Analogue output:

Output range	0 mA...20 mA
Accuracy	0.5% of range
Max. burden	150 Ω
Linearization	Linear, Quadratic
No. of break points	5
Output value limits	$\pm 120\%$ of nominal output
Response time (measurement and analogue output)	depends on set general average interval (0.1 s – 5 s)
Residual ripple	< 1 % p.p.

Outputs may be either short or open-circuited. They are electrically insulated from each other and from all other circuits.

Output range values can be altered subsequently (zoom scale) using the setting software, but a supplementary error results.

Digital input:

Purpose	Tariff input, Pulse input, General purpose digital input
---------	--

Tariff input

No. of inputs per module	2
Rated voltage	5 V...48 V _{AC/DC} * 110 \pm 20 % V _{AC/DC} * 230 \pm 20 % V _{AC/DC} *
Frequency range	45 Hz...65 Hz

*Depends on a build in hardware

Pulse input

No. of inputs per module	2
Rated voltage	5 V- 48 V _{DC} ($\pm 20\%$)
Max. current	8 mA (at 48 V _{DC} + 20 %)
Min. pulse width	0.5 ms
Min. pulse period	2 ms
SET voltage	(40...120) % of rated voltage
RESET voltage	(0...10) % of rated voltage

General purpose digital input

No. of inputs per module	2
Voltage	5 V...48 V _{AC/DC} * 110 \pm 20 % V _{AC/DC} * 230 \pm 20 % V _{AC/DC} *

*Depends on a build in hardware

Digital output:

Type	Relay switch
No. of outputs per module	2
Purpose	Alarm output, General purpose Digital output, Pulse output, Status output (watchdog)
Rated voltage	230 V _{AC/DC} \pm 20% max
Max. switching current	1000 mA
Contact resistance	\leq 100 m Ω (100 mA, 24 V)
Impulse	Max. 4000 imp/hour Min. length 100 ms

Type

No. of outputs per module	1
Purpose	Alarm output, General purpose digital output
Max. switching power	40 VA
Rated voltage	230 V _{AC/DC} \pm 20% max
Max. switching current	1000 mA
Contact resistance	\leq 100 m Ω (100 mA, 24 V)

Type

No. of outputs per module	2
Purpose	Pulse output
Rated voltage	40 V _{AC/DC}
Max. switching	30 mA (R _{ONmax} = 8 Ω)
Pulse length	programmable (2 ms... 999 ms)

Type	Relay switch
No. of outputs	1 x watchdog + 1 x relay output
Normal operation	Relay in ON position
Failure detection delay	≈ 1.5 s
Rated voltage	230 V _{AC/DC} ±20 % max
Max. switching current	1000 mA
Contact resistance	≤ 100 mΩ (100 mA, 24 V)

Power Supply

Standard:	CAT III 300V
Nominal voltage AC	48 V... 276 V
Nominal frequency	40 Hz... 65 Hz
Nominal voltage DC	20 V... 300 V
Consumption (max. all I/O)	< 8 VA
Power-on transient current	< 20 A; 1 ms

AC power supply	CAT III 300 V
Nominal voltage AC	110 V, 230 V or 400 V
Nominal frequency	40 Hz... 65 Hz
Consumption (max. all I/O)	< 8 VA

Safety

Safety:	protection class II
ⓘ ⓘ	functional earth terminal must be connected to earth potential!
	Voltage inputs via high impedance
	Double insulation for I/O ports and COM ports
Pollution degree:	2
Test voltages:	U _{AUX} against SELV circuits – 3.51 kV rms
	Other circuits to functional earth – 2.21 kV rms
EMC:	Directive on electromagnetic compatibility 2004/108/EC
	In compliance with EN 61326-1:2013 for industrial environment
Protection:	In compliance with EN 60592: 1997/A1:2000
	Front side (with protection cover for memory slot): IP40
	Rear side (with protection cover): IP20

Mechanical

Dimensions	96 mm × 96 mm × 96.5 mm
Mounting	Panel mounting
	96 mm × 96 mm
Required mounting hole	92 mm × 92 mm
Enclosure material	PC/ABS
Flammability	Acc. to UL 94 V-0
Weight	550 g
Enclosure material	PC/ABS
	Acc. to UL 94 V-0

Ambient conditions

Ambient temperature	K55 temperature class
	Acc. to EN 61557-12
	-10 °C ...55 °C
Storage temperature	-40 °C to +70 °C
Ambient humidity	≤ 75% r.h. (no condensation)
Max. storage and transport humidity	≤ 90% r.h. (no condensation)
Voltage and Current max. temperature influence limit	± 20 ppm / K (10 V-600 V; 0.05 A-10 A) (T _{amb} : -30°C to +70°C)

Real time clock

A built-in real time clock is also without external synchronization very stable when device is connected to auxiliary power supply. For handling shorter power interruptions without influence on RTC, device uses high capacity capacitor battery. It ensures auxiliary supply (for internal RTC only) for more than two days of operation (6 years with battery).

To enable clock operation backup supercap or battery is built-in.

Supercap life span	approx. 2 days
Type	Low power embedded RTC
RTC stability	< 1 sec / day
Battery life span	approx. 6 years (at 23 °C)

Connection cables

MC 750 Network Recorder is equipped with European style pluggable terminals for measuring voltages, auxiliary supply, communication and I/O modules.

Measuring current cables can be connected in two ways. They shall be attached as through-hole connection without screwing or as detachable screw terminals.

NOTE: Stranded wire must be used with insulated end sleeve to assure firm connection.

Voltage inputs (4)	$\leq 2.5 \text{ mm}^2$, AWG 24-12 single wire
Current inputs (3)	$\leq \varnothing 6 \text{ mm}$ one conductor with insulation
Supply (3)	$\leq 2.5 \text{ mm}^2$, AWG 24-12 single wire
Com (5), I/O (6)	$\leq 2.5 \text{ mm}^2$, AWG 24-12 single wire

MiQen - setting and acquisition Software

MiQen software is intended for supervision of **MC 750** and many other instruments on a PC. Network and the device setting, display of measured and stored values and analysis of stored data in the device are possible via the serial, Ethernet or USB communication. The information and stored measurements can be exported in standard Windows formats. Multilingual software functions on Windows XP operating system or higher.

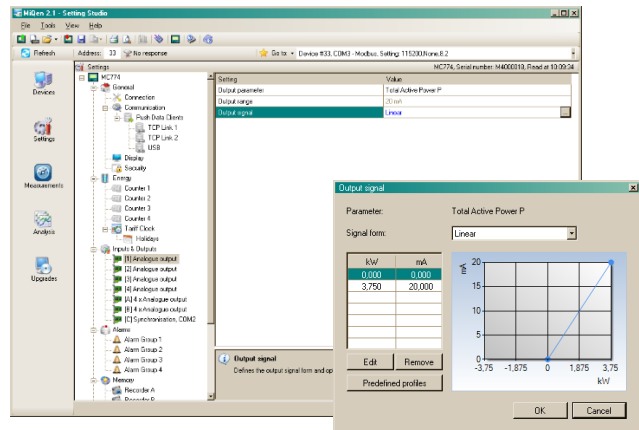

Figure 9 **MiQen setting and acquisition software**

MiQen software is intended for:

- Setting all of the instruments parameters (online and offline).
- Viewing current measured readings and stored data.
- Setting and resetting energy counters.
- Complete I/O modules configuration.
- Evaluation of the electricity supply quality in compliance with SIST EN 50160.
- Viewing and exporting time-stamped PQ anomaly details.
- Upgrading instruments firmware.
- Searching the net for devices.
- Virtual interactive instrument.
- Comprehensive help support.

NOTE!

MiQen software functions depend on the type of connected device.

CONNECTION

Two possible connections of current are available, through-hole connection and terminal connection (see pictures below).

System/connection

Through-hole connection assignment

Terminal connection assignment

1b (1W1b)

Single-phase connection

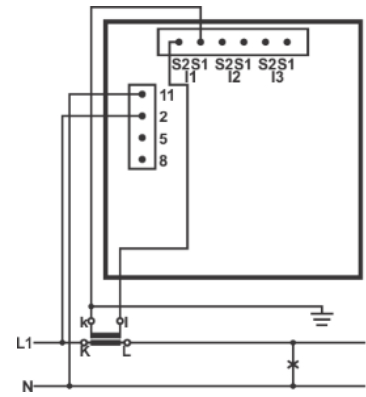
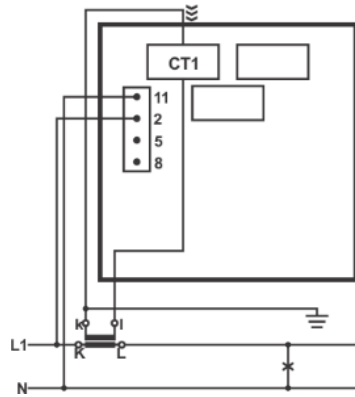

3b (1W3b)

Three-phase, three-wire connection with balanced load

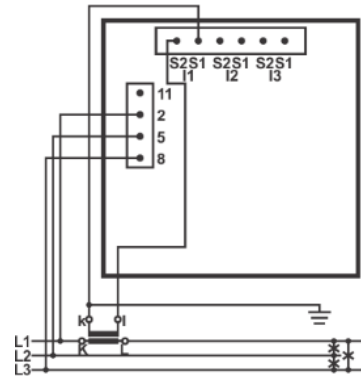
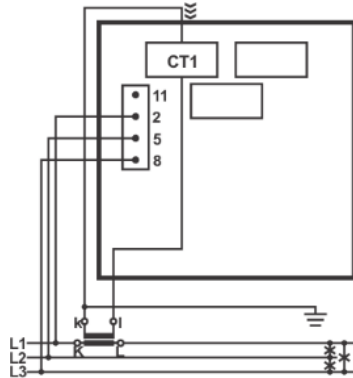

3u (2W3u)

Three-phase, three-wire connection with unbalanced load.

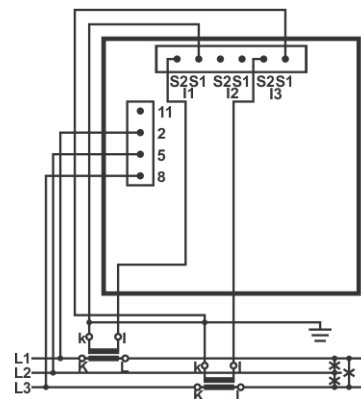
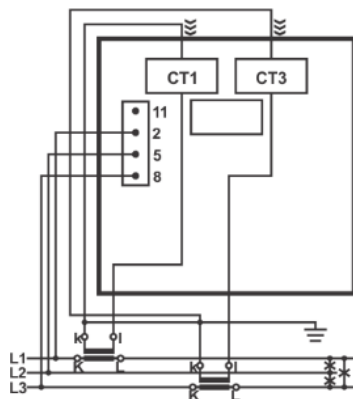

System/connection

Through-hole connection assignment

Terminal connection assignment

4b (1W4b)

Three-phase, four wire connection with balanced load

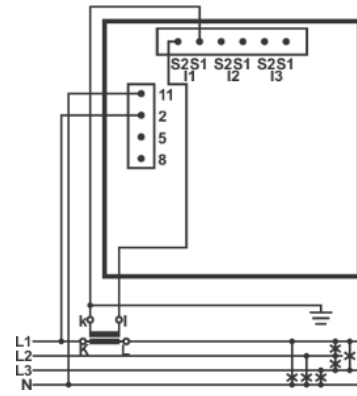
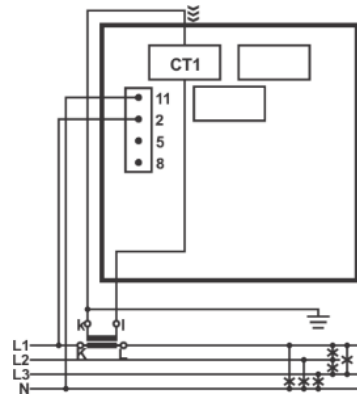

4u (3W4)

Three-phase, four wire connection with unbalanced load.

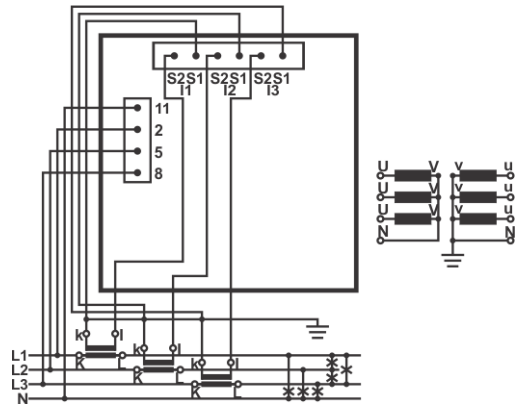
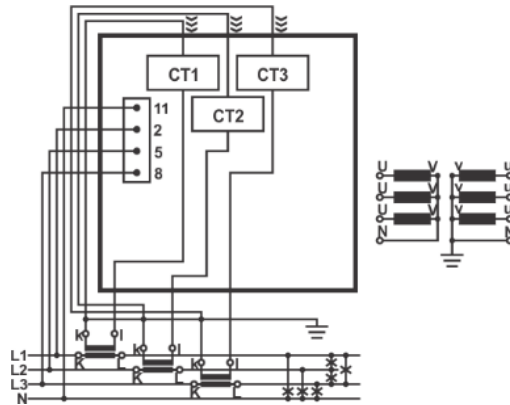

DIMENSIONAL DRAWING

Dimensions for MC 750 (through-hole connection assignment):

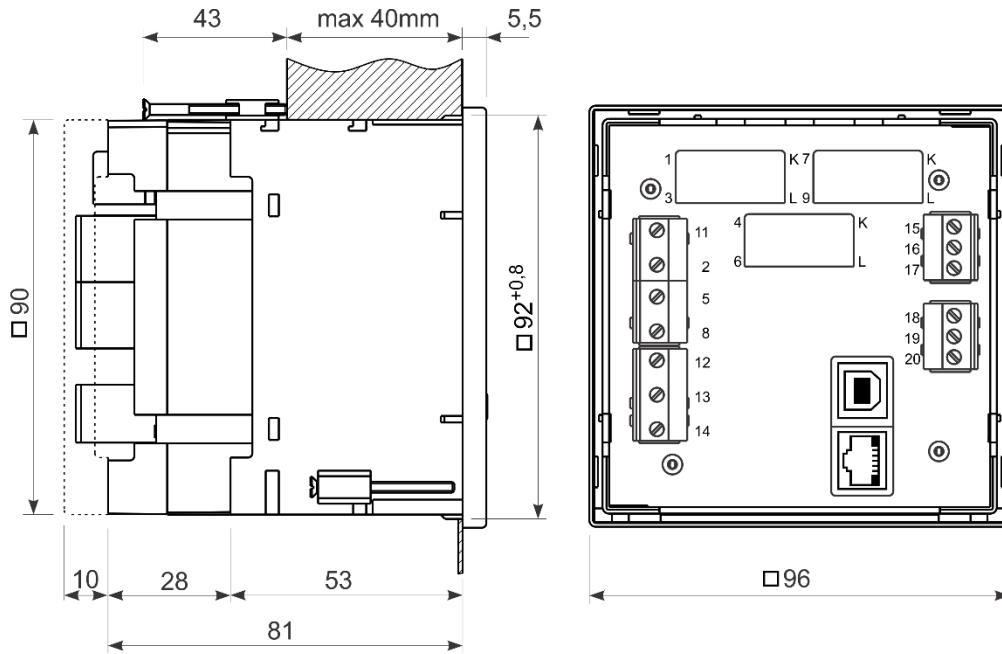

Dimensions for MC 750 (terminal connection assignment):

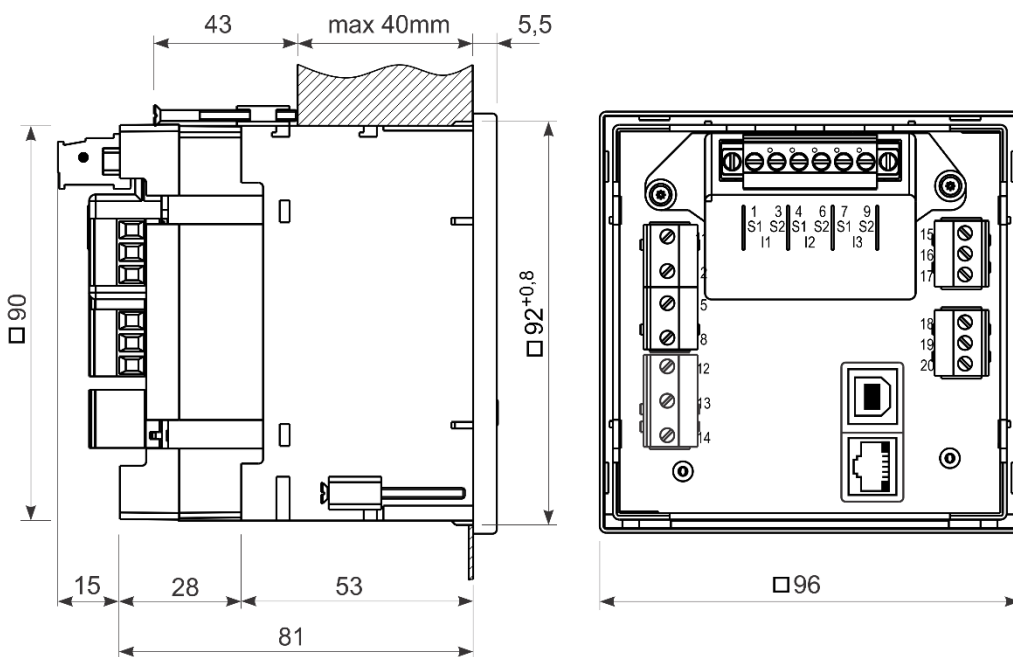

Connection table

Function			Connection	Comment
Measuring input:	AC current	IL1	1/3	❶ CAT II 600V CAT III 300V
		IL2	4/6	
		IL3	7/9	
	AC voltage	UL1	2	❶ CAT II 600V CAT III 300V
		UL2	5	
		UL3	8	
		UN	11	
Inputs/outputs:	Module 1/2	②+	15	
		②⏏ (common)	16	
		②+	17	
	Module 3/4	②+	18	
		②⏏ (common)	19	
		②+	20	
Auxiliary power supply:	+ / AC (L)	13	❶ CAT III 300V ⚡ GROUND terminal must be always connected !!	
	- / AC (N)	14		
	GROUND	12		
Communication:	RS485	A	21	RS232 and RS485 are both supported, but only one at the time can be used! In case of Ethernet/USB communication, terminals from 21 to 25 are not used (unconnected).
		B	22	
	RS232	RX	23	
		GND	24	
		TX	25	
Communication: DB9 female	RS232	Rx	3	
		⏏	5	
		Tx	2	
	RS485	B	7	
		A	8	

Table 6: Connections

DATA FOR ORDERING

When ordering **MC 750 Network Recorder**, all required specifications shall be stated in compliance with the ordering code. Additional information could be stated. Note that fixed or programmable specifications are not part of ordering code.

General ordering code

The following specifications shall be stated:

Device Type	Nominal freq.	Aux. power supply	Comm. COM1	I/O module 1/2	I/O module 3/4	RTC backup supply	Current connection
MC 750	X	X	X	X	X	X	X
							T Through Hole Transformer *
							C Screw Terminal Connector
						C	Supercap*
						B	Battery
				N			Without *
				A			2× Analogue output
				S			2× Pulse output
				M			2× Relay (alarm) output
				B			1× Bistable relay (alarm) output
				W			1× Status (Watchdog) + 1× Relay output
				I			2× Analogue input - mA _{DC}
				U			2× Analogue input - V _{DC}
				R			2× Analogue input - R/Temp.
				P			2× Pulse input 5 - 48 V _{DC}
				D			2× Digital input 230 V _{AC/DC}
				E			2× Digital input 110 V _{AC/DC}
				F			2× Digital input 5 - 48 V _{AC/DC}
				T			2× Tariff input 230 V _{AC/DC}
				Z			2× Tariff input 110 V _{AC/DC}
				Y			2× Tariff input 5 - 48 V _{AC/DC}
				G			RS232 Communication - COM2
				C			RS485 Communication - COM2
				X			Output Extender - COM2
			T				RS232/RS485 Terminal *
			R				RS232/RS485 DB9
			E				Ethernet & USB
	U						20 ... 300 V _{DC} , 48 ... 276 V _{AC} *
	D						110 V _{AC}
	E						230 V _{AC}
	F						400 V _{AC}
	S						50, 60 Hz *
	A						400 Hz
	B						16 2/3 Hz

Not available for Nominal freq. 16 2/3 Hz

I/O module 1/2 only

I/O module 1/2 only

I/O module 1/2 only

I/O module 3/4 only

I/O module 3/4 only

I/O module 3/4 only

*- standard

Example of ordering:

MC 750 with a universal supply is connected to 230 V voltage and 5 A secondary current on 50 Hz network. Ethernet & USB communication, watchdog output (plus one relay output) as I/O 1/2 and two pulse outputs as I/O 3/4. RTC with supercap supply. Through-hole type current transformers.

Voltage and current nominal value are due to auto-range fixed to max. nominal value and are therefore omitted from ordering code.

Connection type is user programmable and is therefore omitted from ordering code. Default is 4u connection.

Example ordering code:

MC 750	S	U	E	W	S	C	T	
								Through Hole Transformer
								Supercap
								2× Pulse output
								1× Status (Watchdog) + 1× Relay output
								Ethernet & USB
								Universal (20 V DC... 300 V DC, 48 V AC... 276 V AC)
								50 Hz, 60 Hz

DICTIONARY:

<i>PQ</i>	<i>Power Quality alias Voltage Quality</i>
<i>RMS</i>	<i>Root Mean Square</i>
<i>PA</i>	<i>Power angle (between current and voltage)</i>
<i>PF</i>	<i>Power factor</i>
<i>VT</i>	<i>Voltage measuring transformer</i>
<i>CT</i>	<i>Current measuring transformer</i>
<i>THD</i>	<i>Total harmonic distortion</i>
<i>Ethernet</i>	<i>IEEE 802.3 data layer protocol</i>
<i>MODBUS</i>	<i>Industrial protocol for data transmission</i>
<i>MiQen</i>	<i>ISKRA setting and acquisition Software</i>
<i>AC</i>	<i>Alternating quantity</i>
<i>RTC</i>	<i>Real Time Clock</i>
<i>IRIG</i>	<i>Inter-range instrumentation group time codes</i>
<i>NTP</i>	<i>Network Time Protocol</i>

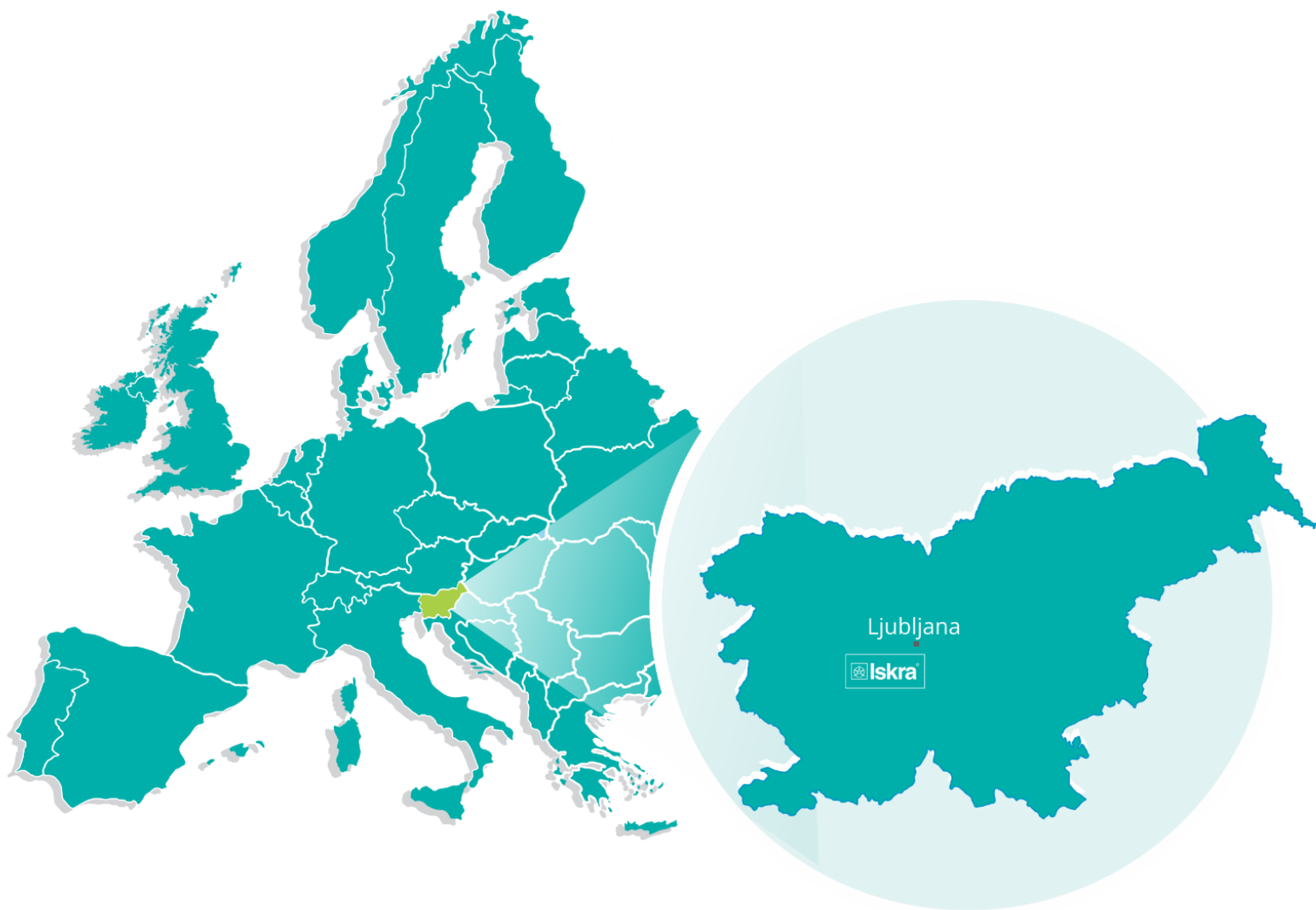

Iskra, d.o.o.
BU Ljubljana

Stegne 21
SI-1000, Ljubljana
Phone: +386 1 513 10 00

Iskra, d.o.o.
BU Capacitors

Vajdova ulica 71
SI-8333, Semič
Phone: +386 7 38 49 200

Iskra, d.o.o.
BU MIS

Ljubljanska c. 24a
SI-4000, Kranj
Phone: +386 4 237 21 12

Iskra, d.o.o.
BU Batteries & Potentiometers

Šentvid pri Stični 108
SI-1296, Šentvid pri Stični
Phone: +386 1 780 08 00

Iskra, d.o.o.
BU Electroplating

Glinek 5
SI-1291, Škofljica
Phone: +386 1 366 80 50

Iskra IP, d.o.o.

Vajdova ulica 71
SI-8333, Semič
Phone: +386 7 384 94 54

Iskra STIK, d.o.o.

Ljubljanska cesta 24a
SI-4000, Kranj
Phone: +386 4 237 22 33

Iskra Lotrič, d.o.o.

Otoče 5a
SI-4244, Podnart
Phone: +386 4 535 91 68

Iskra ODM, d.o.o.

Otoče 5a
4244, Podnart
Phone: +386 1 513 10 00

Iskra Tela L, d.o.o.

Omladinska 66
78250, Laktaši
Phone: +387 51 535 890

Iskra Sistemi - M dooel

UI, Dame Gruev br. 16/5 kat
1000, Skopje
Phone: +389 75 444 498

Iskra Commerce, d.o.o.

Hadži Nikole Živkoviča br. 2
11000, Beograd
Phone: +381 11 328 10 41

Iskra Hong Kong Ltd.

33 Canton Road, T.S.T.
1705, China HK City
Phone: +852 273 00 917



Iskra, d.o.o.
Stegne 21
SI-1000 Ljubljana, Slovenia

Phone: +386 (0) 1 513 10 00
www.iskra.eu